

Installation Instructions

ThermoCall TC4

Entry/Advanced



Thermo Call TC4

1

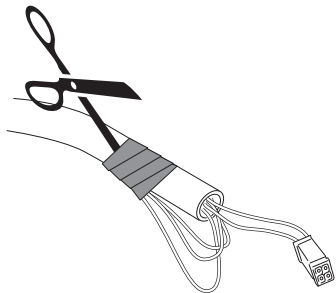

2

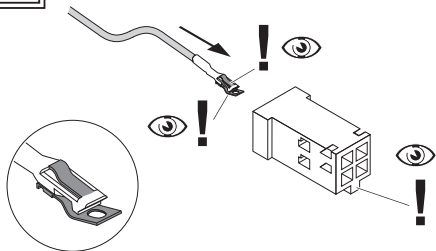

3

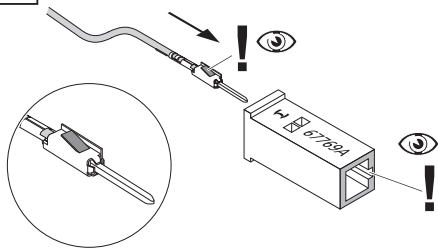

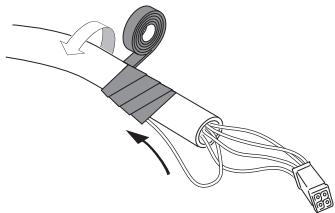

4



Thermo Call TC4

5

ThermoCall TC4 Entry

	I	II	III	IIII
	vi	sw	rt	br
	ge	---	rt	br

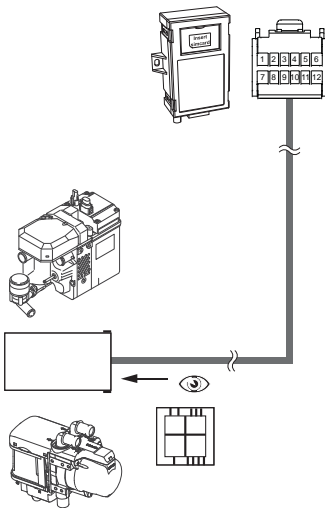

Please refer to the corresponding heater documentation for all other heater integrations.





Thermo Call TC4

6

ThermoCall TC4 Advanced

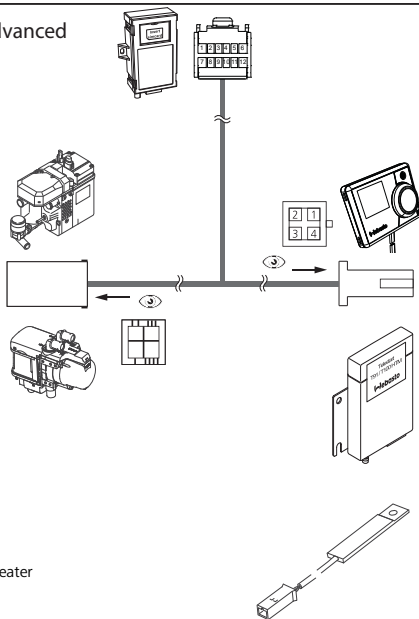
	I	II	III	III
	vi	sw	rt	br
	ge	--	rt	br

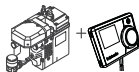
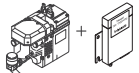
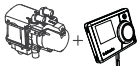
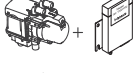

1	2	3	4	
--	gr	rt	br	 
ge	---	rt	br	   

Please refer to the corresponding heater documentation for all other heater integrations.



Improper installation or repair of Webasto heating and cooling systems can cause fire or the leakage of deadly carbon monoxide leading to serious injury or death.

To install and repair Webasto heating and cooling systems you need to have completed a Webasto training course and have the appropriate technical documentation, special tools and special equipment.

Only genuine Webasto parts may be used. See also Webasto air and water heaters accessories catalogue.



NEVER try to install or repair Webasto heating or cooling systems if you have not completed a Webasto training course, you do not have the necessary technical skills and you do not have the technical documentation, tools and equipment available to ensure that you can complete the installation and repair work properly.

ALWAYS carefully follow Webasto installation and repair instructions and heed all WARNINGS.

Webasto rejects any liability for problems and damage caused by the system being installed by untrained personnel.

ThermoCall TC4

GB Table of Contents

Installation Instructions	1
General information	1
Certification	1
Scope of Delivery Entry	1
Scope of Delivery Advanced	2
Adapting wiring harness	2
ThermoCall TC4 Entry:	2
ThermoCall TC4 Advanced:	2
Legend	2
SIM card	3
Installation	4
Installing GSM module	4
Installing GSM antenna	4
Installing button with indicator lamp	4
Connection	5
Connector assignment of GSM module	5
Connection of an alarm system installed in the vehicle (Advanced)	6
Connection of an external temperature sensor (Advanced)	6
Connection to heater	7
Thermo Top Evo or Thermo Top E/C	7
Thermo Top Evo or Thermo Top E/C with MultiControl (Advanced)	7
Thermo Top Evo or Thermo Top E/C with Telestart T91/T100 HTM (Advanced)	7
Summer/winter connection (only Advanced, only for Thermo Top E/C)	8
Initial start-up	8
Technical data	9
Drawing of installation location for GSM module in vehicle	10

Installation Instructions

General information

With ThermoCall TC4 the following Webasto heaters can be operated with a mobile or landline phone:
Water heaters:

- Thermo Top E/C
- Thermo Top Evo
- Thermo Pro 50 Eco
- Thermo Pro 90
- Thermo 120/150 STD

Air heaters:

- Air Top 2000 STC
- Air Top Evo 40
- Air Top Evo 55

Detailed information can be found in the heater operating instructions. The function cannot be guaranteed in conjunction with OE heaters.

Please turn over these installation instructions to the customer together with the operating instructions.

Certification

The CE marking and the E-marking are located on the adhesive label on the module.

Scope of Delivery Entry

1. GSM module ThermoCall TC4
 2. Entry wiring harness
 3. GSM antenna
 4. Button with indicator lamp
 5. Self-tapping screws
- and (not shown):
-Quick Start Guide
-CD with operating and installation instructions

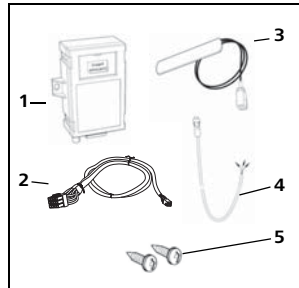

ThermoCall TC4

Scope of Delivery Advanced

1. GSM module ThermoCall TC4
2. Advanced wiring harness
3. GSM antenna
4. Button with indicator lamp
5. Self-tapping screws

and (not shown):

-Quick Start Guide

-CD with operating and installation instructions

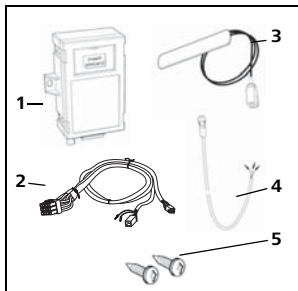

Adapting wiring harness

The included wiring harness must be adjusted with corresponding "pinning into" the existing installation situation (heater selection).

ThermoCall TC4 Entry:

Strip the tied-back wires at the heater connector, connect the required wires as shown in the illustrations 1 to 4 and illustration 5 and then insulate and tie back the wire ends that are not required.

ThermoCall TC4 Advanced:

Strip the tied-back wires at both connectors for the heater and control element, connect the required wires as shown in the illustrations 1 to 4 and illustration 6 and then insulate and tie back the wire ends that are not required.

Legend

To illustrations 1 to 6.

br	brown
ge	yellow
gr	grey
rt	red
sw	black
vi	violet
---	not in use

Thermo Top E/C

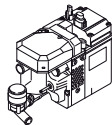

Thermo Top Evo

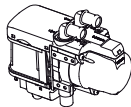

SIM card

A SIM card not included in the delivery scope is required to operate the unit.

Both 1.8 V and 3 V SIM cards of a network operator, which supports the GSM 900/1800 mobile communications standard, can be used.

Always observe any information of the respective network operator when operating the SIM card. No warranty can be given for the SIM card used. The function should be checked separately in individual cases.

Before inserting the SIM card, the PIN code must be changed to 1234 with a mobile phone. Information on this topic is contained in the respective operating instructions of the mobile phone.

All data which may be present on the SIM card will be deleted when commissioning the GSM module.

The SIM card is inserted under the sliding cover on the top of the GSM module with the angled side opposite the hinge and with the chip side facing downward.

Only insert or remove the SIM card in the deenergised state.

The range is dependent on the respective network operator. Costs result from the operation of a SIM card. Information on this topic and on roaming charges abroad and in areas close to the border (due to network overlapping) can be obtained from the respective network operator. No liability can be accepted for any costs arising.

ThermoCall TC4

Installation

Installing GSM module

The GSM module must be installed in the passenger compartment.

- Determine the installation location in the passenger compartment (under the instrument panel, when retrofitting preferably near the MultiControl or the radio receiver)
- Fasten the GSM module with self-tapping screws (ensure sufficient clearance for the connection of the wiring harness and the antenna)
- Watch vehicle parts located behind the module when mounting it with the self-tapping screws! Contacts/plug connections must face downwards.



NOTE

Note down the installation location of the GSM module on the last page of these installation instructions, e.g. for replacing SIM card!

Installing GSM antenna

The antenna must be installed on the front or rear window. However, never in the tinted area or under the heating wires of the window heater or wires of the window antenna.

- Clean the window thoroughly with a cleaning cloth
- Pull the protective film off the antenna and glue on the antenna (maintain a minimum distance of 30 mm from metal parts)
- Route the antenna cable to the GSM module (never shorten or kink) and connect to the module

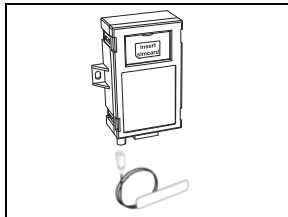

Installing button with indicator lamp



NOTE

- The supplied push button **must** be installed.
- Follow initial start-up procedure.
- Install push button in view of the driver.

- Drill an 8 mm diameter hole in a dummy switch or another suitable location easily accessible to the driver (coordinate the installation location with the vehicle owner if necessary)
- Mount the push button in the 8 mm dia. hole
- Route the push button wiring harness to the 12-pin connector on the module and connect them (blue wire on Pin 9, green on Pin 10 and red on Pin 11)

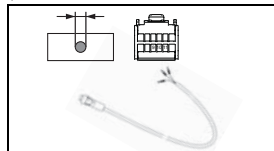

Connection Connector assignment of GSM module

Socket	Function	Remarks	Entry	Advanced
1	12 - 24 V (+30)		✓	✓
2	Earth = 0		✓	✓
3	Output of parking heater	only for Thermo Top E/C	✓	✓
4	additional analogue output, 12-24 V positive *	for 2nd installed heater with analogue control	✗	✓
5	Earth output for summer function (fan only)	only for Thermo Top E/C	✗	✓
6	W bus communication with parking heater or MultiControl/ Telestart	only for Thermo Top Evo	✓	✓
7	not in use (optional Input 1 for alarm system)	+12 V	✗	✓
8	Input 2 (for MultiControl/Telestart)	only for Thermo Top E/C	✗	✓
9	Earth for push button including indicator lamp (blue wire)		✓	✓
10	ON/OFF for push button including indicator lamp (green wire)		✓	✓
11	Output for indicator lamp in push button (red wire)		✓	✓
12	not in use		✓	✓

*:The connection may vary depending on the installed 2nd heater. Information on the integration is contained in the respective heater installation instructions.

ThermoCall TC4

Connection of an alarm system installed in the vehicle (Advanced)

The vehicle owner receives a text message when the alarm system is triggered.

Insert the wire in Pin 7 of the 12-pin connector and connect it to the output of the alarm system (must be a +12 V signal).

To define which text message content the ThermoCall TC4 is to use to inform you, send the following text message command to the ThermoCall TC4 following initial start-up: **1234IBANK:"Entry command"**. The entry command can, for example, be Alarm.

The alarm can be sent to up to 5 phone numbers. To define which phone numbers are to be used, send the following text message command to the ThermoCall TC4: **1234NBANK:XXX:YYY:ZZZ:VVV:WWW**

XXX:YYY:ZZZ:VVV:WWW = phone numbers to be entered by the user, e.g.:
+436641234567:+4369912345678 : etc.

Connection of an external temperature sensor (Advanced)

This is required for measuring the temperature outside the ThermoCall TC4 (e.g. for cargo areas) and for using the temperature alarm function.

Required material:

- W bus temperature sensor 9023181A (not required in combination with Telestart T100 HTM)
 - Y-adapter 9001505A (only required if a control element is connected after the ThermoCall TC4)
 - See the Webasto Accessories Catalogue for any required extensions.
- Carry out the connection as shown in the following drawing and illustrations on the inner cover pages.

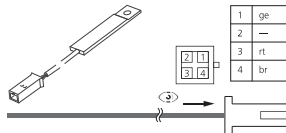

To use the temperature alarm, the phone numbers to be notified must be reported to the ThermoCall TC4. To define the phone numbers, the

following text message command must be sent to the ThermoCall TC4: **1234NBANK:XXX:YYY:ZZZ:VVV:WWW**
XXX:YYY:ZZZ:VVV:WWW = phone numbers to be entered by the user, e.g.:
+436641234567:+4369912345678 : etc.

For details, see operating instructions.

Connection to heater

Thermo Top Evo or Thermo Top E/C

- Connect wiring harness to GSM module.
- Connect the 4-pin connector of the heater wiring harness to the 4-pin GSM module wiring harness

Entry

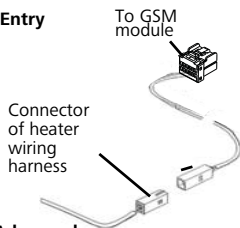

Advanced:

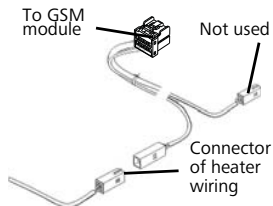

Thermo Top Evo or Thermo Top E/C with MultiControl (Advanced)

- Connect wiring harness to GSM module.
- Connect the 4-pin connector of the heater wiring harness to the 4-pin GSM module wiring harness
- Connect the 4-pin GSM module connector to the MultiControl

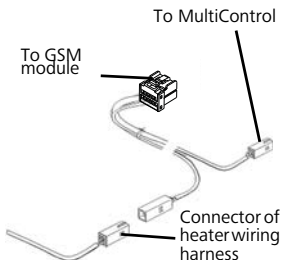

Thermo Top Evo or Thermo Top E/C with Telestart T91/T100 HTM (Advanced)

- Connect wiring harness to GSM module.
- Connect the 4-pin connector of the heater wiring harness to the 4-pin GSM module wiring harness
- Connect 4-pin GSM module connector to the Y-adaptor of the Telestart

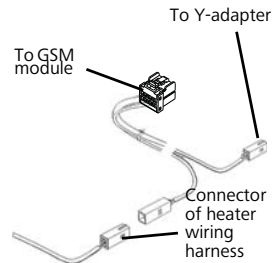

ThermoCall TC4

Summer/winter connection (only Advanced, only for Thermo Top E/C)

- The summer/winter wire is not included in the delivery scope and must be ordered separately
- Connect the violet wire to the violet wire of the heater wiring harness using a connector
- Plug into a free slot of the 4-pin connector of the heater wiring harness



Initial start-up

- Connect the 12-pin connector of the GSM module wiring harness to the module
- After applying voltage, the indicator lamp flashes 2x per second.
- After about 60 seconds, the indicator lamp flashes 1x per second.



NOTE

Depending on the dial-in time of the SIM card, it can take a up to 5 minutes until the system is finally ready for operation

- As soon as operational readiness is achieved, program the ThermoCall TC4 and put it into operation according to the operating instructions.
- To query the firmware version send the text message command "VERSION" to the ThermoCall TC4



NOTE

Check that the indicator lamp in the button is functioning correctly.

Operation of the ThermoCall TC4 is only permitted with a fully functional indicator lamp.

- Indicator lamp flashes to show the system is ready for operation

- Follow the heater initial start-up procedure.

Technical data

	Values	Entry	Advanced
Rated voltage	12 V DC	✓	✗
Rated voltage	12 / 24 V DC	✗	✓
Bias current consumption	0.005 A	✓	✓
Current consumption during data transfer	0.040 A	✓	✓
Max. output current	1.00 A	✓	✓
Max. input voltage	35 V	✗	✓
Switching voltage for inputs	+5.5 V	✗	✓
Permissible ambient temperature	-40 °C to +85 °C	✓	✓
Permissible storage temperature	-40 °C to +85 °C	✓	✓
Dimensions (LxWxH)	95x55 (75) x30 mm	✓	✓
Weight	100 g	✓	✓
Protection type	IP42	✓	✓
Material	PBT	✓	✓

ThermoCall TC4

Drawing of installation location for GSM module in vehicle

Note or sketch the installation location of the GSM module in the following field for possible service cases.

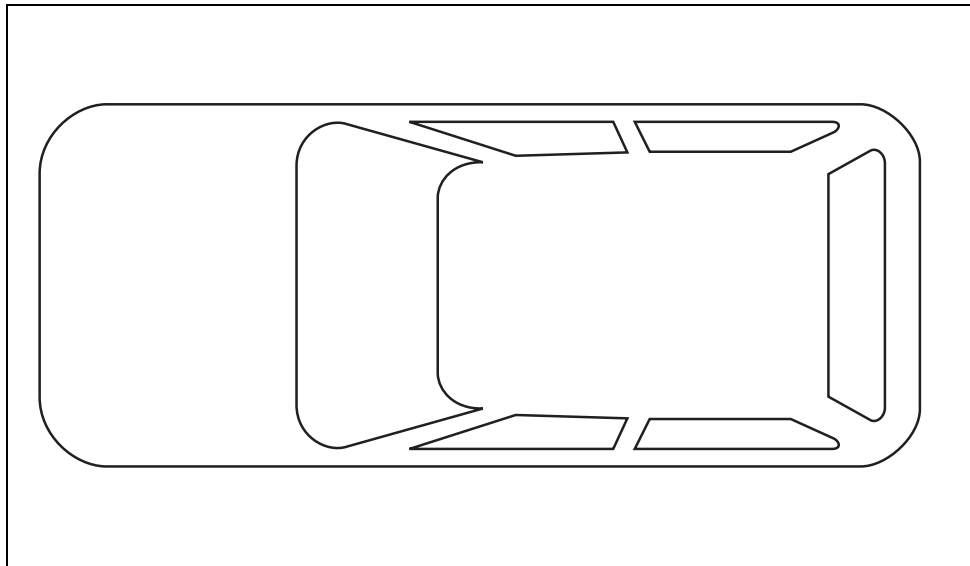

In multilingual versions the German language is binding.

The telephone number of each country can be found in the Webasto service center leaflet or the website of the respective Webasto representative of your country.

Webasto Thermo & Comfort SE
Postfach 1410
82199 Gilching
Germany

Visitors' address:
Friedrichshafener Str. 9
82205 Gilching
Germany

Internet: www.webasto.com

Technical Extranet: <http://dealers.webasto.com>